

SERVICE REQUIREMENTS

⚠ WARNING! *Read and understand the contents of this manual before attempting to service WL290 Water Treatment System. Failure to follow the instructions in this manual could result in death, serious personal injury, or severe property damage. Only trained and qualified technicians should attempt to install, maintain, or service Waterlogic Equipment.*

1. Visually inspect all electrical and water connections for signs of wear or damage.

⚠ DANGER! **HIGH VOLTAGE ELECTRICAL HAZARD.** *Unplug before inspection and service.*

2. **Waterlogic** recommends changing the UV Lamp Assembly and Wiring Harness must be replaced every 12 months.

8UV Lamp Assembly
Part Number CT-2083 WLCP Part Number 10-2350



NOTE: The Glow Starter shown may appear blackened which is normal.



⚠ WARNING! **ULTRAVIOLET RADIATION.** *Protect your skin and eyes against ultraviolet rays. Never look directly at an operating UV light. Disconnect before removing UV Lamp.*

⚠ CAUTION! **UV LAMPS ARE HAZARDOUS.** *Lamps are considered Hazardous Waste and must be disposed of accordingly. Refer to Product MSDS sheet for details.*

3. Clean the Quartz Sleeve that surrounds the UV lamp with a non-abrasive cloth, descaling solution, or ultrasonic bath if needed when changing UV Lamps.

⚠ CAUTION! **UV SYSTEM IS FRAGILE.** *Never handle the UV lamp or Quartz Sleeve with bare hands. UV Lamp and quartz sleeve must be free of oils and contaminants to ensure proper operation. Use a soft non-abrasive cloth to clean.*

4. Inspect the Quartz Sleeve O-ring for wear or damage and replace as necessary.
5. Ensure there is adequate (minimum of 2") clearance around the unit and clean the condenser grill and compressor fan to provide efficient cooling system operation.
6. Sanitize the Cold Tank per instructions in the pre-installation procedures.
7. Clean and sanitize external surfaces of the unit. Use soap and water or chemicals that are compatible with ABS plastic and will not damage or degrade the product surfaces.
8. Remove and clean the Faucet. Replace as needed.

⚠ WARNING! **SANITIZER MAY CONTAIN HAZARDOUS CHEMICALS.** *Use of proper personal protective equipment such as rubber gloves and eye protection is required.*

MAIN PCB WIRE DRAWING

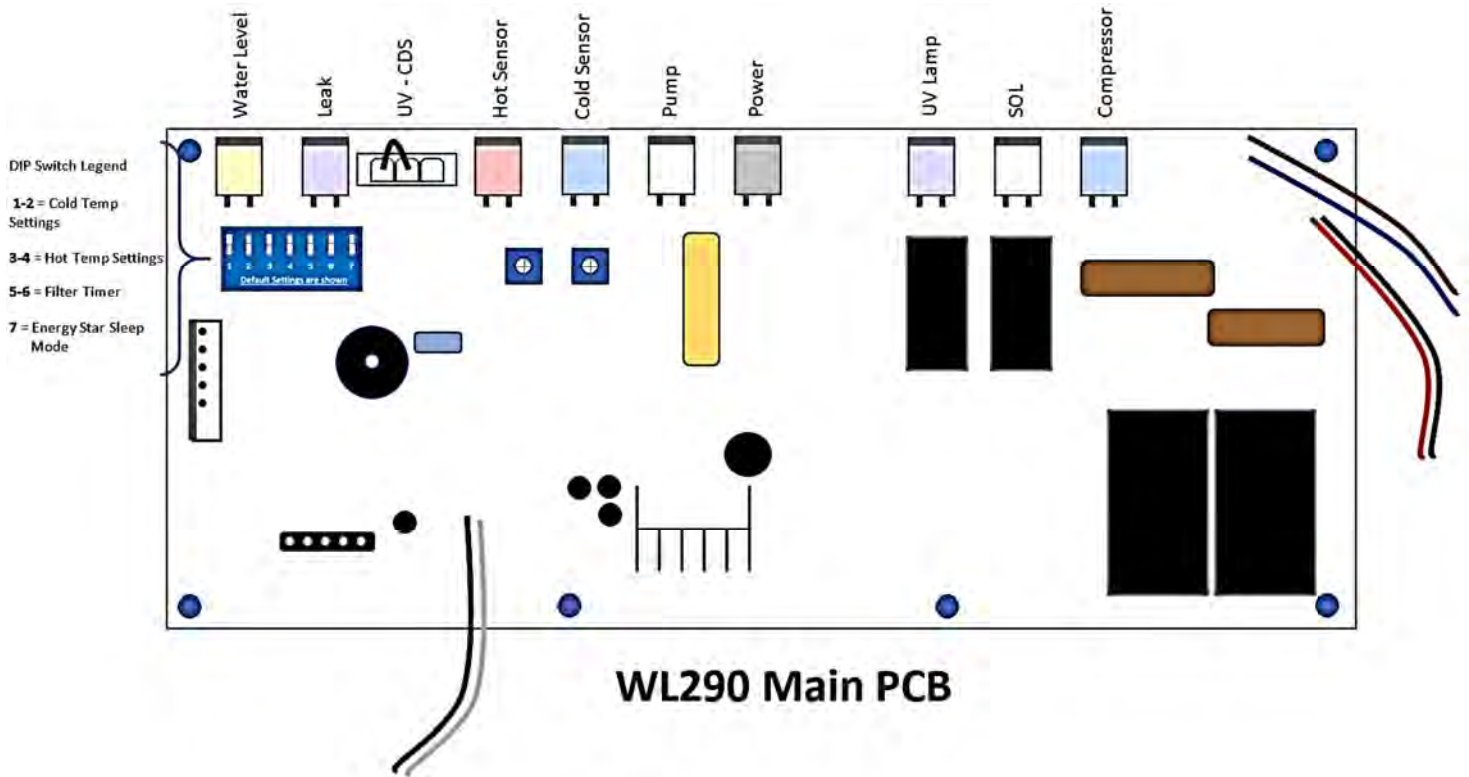

REPLACEMENT COMPONENTS

Component	WLCP Part No.	Frequency of Replacement
UV Lamp Assembly, 8 Watt	10-2350	Every 12 months Part No CT-2083
Carbon Air Filter	19-1052	Every 12 months Part No. PU-4108
Recirculation GAC Filter	AK-0005-L00-00	Every 12 months Part No. AK-0005-L00-00
Hot Tank Assembly 1.6 Liter with Sensor 500W	HT-0010-I00-00	Every 3-5 Years depending on usage Part No. HT-0010-I00-00
GAC Filter - 10" Carbon Activated Inline Filter - Optional	FT-0035 <i>Element Only PN FT-0038</i>	Every 6-months or as required. Local water conditions will determine proper filter type and maintenance schedule. FT-0035-IL-WLT
Carbon Block - 10" CBC 1 Micron Lead and Cyst Reduction Inline Filter – Optional	FT-0063 <i>Element Only PN FT-0064</i>	Every 6-months or as required. Local water conditions will determine proper filter type and maintenance schedule. FT-0063-IL-WLT
Sediment Filter - 10" Sediment 20 Micron Inline Filter - Optional	FT-0053 <i>Element Only PN FT-0055</i>	Every 6-months or as required. Local water conditions will determine proper filter type and maintenance schedule. FT-0053-IL-WLT

Replacement parts can be obtained from **Waterlogic** or an **Authorized Waterlogic Dealer**. See Parts Layouts, Drawings, and Lists for additional repair parts.

Hot Tank Service

Hot Tanks (with controls) must be replaced at least every 3-5 years depending on usage. Descaling Hot Tank may be required on a regular basis depending upon filtration and local water conditions. See Service Section.

NOTE:

At the **end of this product's life**, ensure that it is disposed of in an environmentally friendly manner which is fully compliant **with all Federal/State/Local Requirements and Guidelines**.

LED INDICATOR LIGHTS

● Heating	● Chilling	● Power
● Sleep	● UV	● Filter



- Power Green Power LED = Power is ON; No Power LED = Power is OFF
- ⚙ Power Flashing Green Power LED = Circulation Pump Fault
- Filter Green Filter LED = Filter Timer Alarm
- Chilling Blue Chilling LED = **WL290** is chilling water and the Compressor is ON.
No Blue Chilling LED = Water is chilled to temperature and the Compressor is OFF.
- ⚙ Chilling Flashing Blue Chilling LED = Cold Fault Alarm (see troubleshooting section of this manual)
- UV Blue UV LED = UV is in operation.
- Heating Red Heating LED = Water is heating.
- Heating No Red Chilling LED = Water is heated to temperature.
- ⚙ Heating Flashing Red Heating LED = Hot Fault Alarm (see troubleshooting section of this manual)
- Sleep Red Sleep LED = Unit is in Sleep Mode (Energy Saver) is ON; No Red LED = Unit is not in Sleep Mode.

All but the Green Power LED Light Flashing indicates the **WL290** has detected a leak. (see troubleshooting section of this manual)

- | | | |
|-----------|------------|----------|
| ⚙ Heating | ⚙ Chilling | ● Power |
| ⚙ Sleep | ⚙ UV | ⚙ Filter |

PROGRAMMING INSTRUCTIONS

DP SET-UP COLD WATER TEMPERATURE

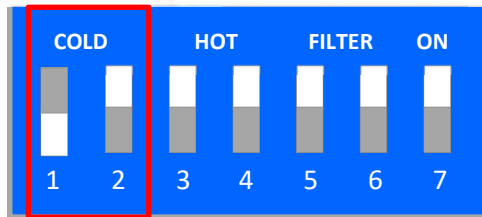
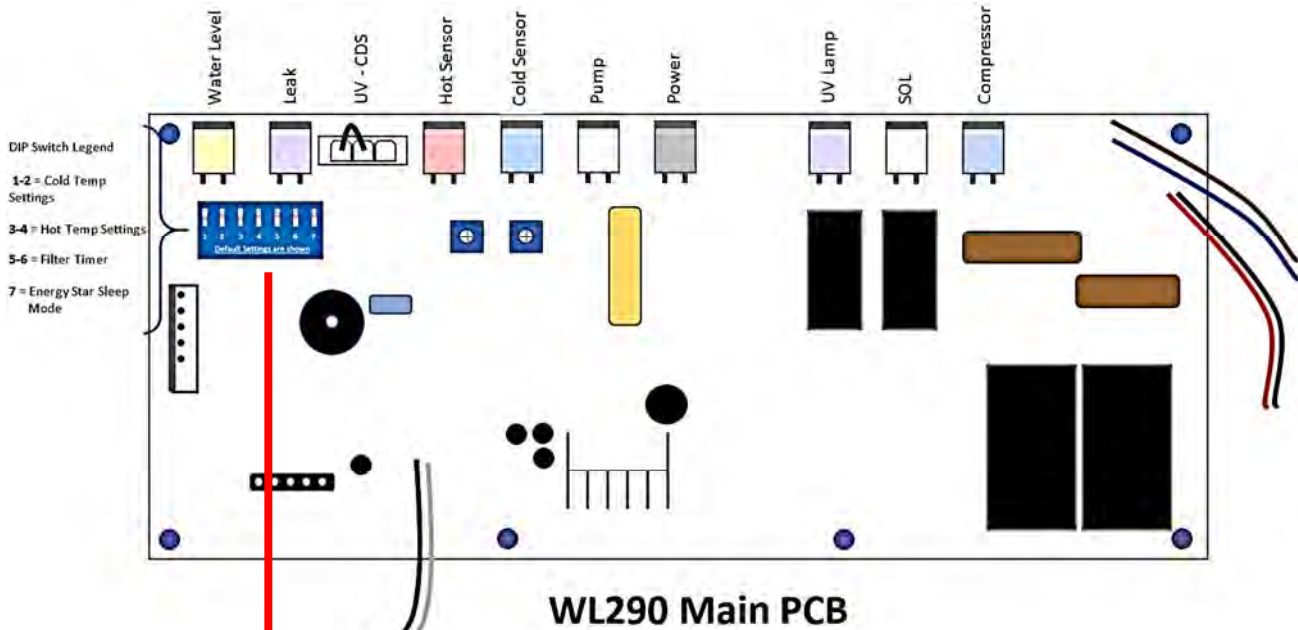

1	2	COLD TEMPERATURE SETTING
☐	☐	3°C (37°F)
☐	☐	5°C (41°F)
☐	☐	5°C (41°F)
☐	☐	7°C (45°F)

} **DEFAULT SETTING - 5°C (41°F)**

DP SET-UP HOT WATER TEMPERATURE

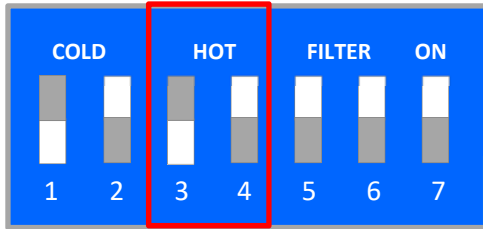

3 4

HOT TEMPERATURE SETTING



80°C (176°F)



85°C (185°F)



85°C (185°F)



93°C (199°F)

DEFAULT SETTING - 85°C (185°F)

DP SET-UP FILTER TIMER

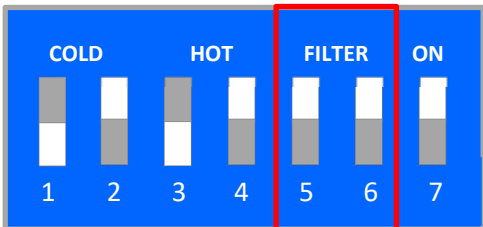

5 6

SET-UP FILTER TIMER



6 Months



9 Months



12 Months



None – DEFAULT SETTING

Filters should be configured to optimize your system. Filters need to be configured and specified to do the job given the local water conditions, usage, maintenance schedule, and placement restrictions.

In order for our filters to perform as represented and to provide the best quality water possible, it is essential that filters be replaced periodically. The frequency of filter changes depends on your water quality and your water usage. For example, if there is a lot of sediment and/or particles in your water, then you will have to change your filters more frequently than a location with little to no sediment. Be sure to replace your filters whenever you notice a decline in the performance, whether it is a drop-in flow rate and/or pressure or an unusual taste in the water.



After Filter Change – push reset button located on back of the **WL290**

DP SET-UP SLEEP MODE (ENERGY SAVER) When in Sleep Mode when there is no incoming water for more than three hours, the **WL290 Water Treatment System** will go to sleep mode automatically and the Red Sleep LED light is on and the heater is turned OFF.

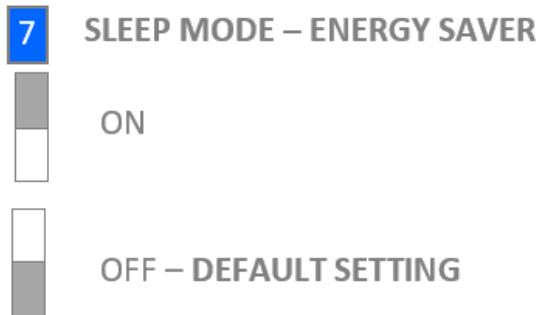
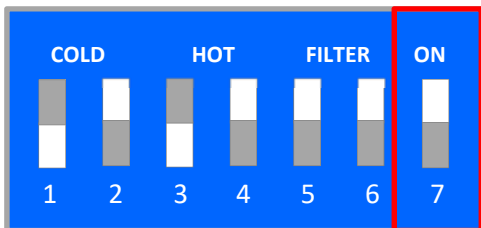

HOT TANK DESCALING INSTRUCTIONS

The Hot Tank requires removal of mineral deposits (descaling) on a regular basis. Typically descaling should take place every 12 months to preserve the long-term health of your unit.

Use non-toxic cleaner such as ScaleKleen, DEZCAL, 20% Citric Acid Solution, or Undiluted Vinegar Solution to remove mineral deposits as directed by the manufacturer depending upon filtration and local water conditions.

Descaling is an important process that removes calcium deposits, or scale, that can build up inside a tank over time. Calcium and scale is non-toxic but left unattended will hinder your unit's performance.

⚠️ WARNING! ***PERSONAL PROTECTIVE EQUIPMENT REQUIRED.** Always ensure proper ventilation and use rubber or nitrile gloves and eye protection when using chemicals. Refer to Material Safety Data Sheet for specific requirements of each product.*

⚠️ CAUTION! ***STAINLESS STEEL TANK DESCALING.** The Hot Tank is made from stainless steel. Ensure descaling solution is compatible with stainless and always flush the unit completely. Dispose in an environmentally safe manner.*

Materials Needed:

- Personal Protective Equipment. Rubber or Nitrile Safety Gloves and Protective Eyewear
- Phillips Screwdriver
- Temperature Gauge
- Water Pitcher or Container to collect water from the faucet
- 5-gallon container or drain basin
- Citric Acid Based Cleaner
- ¼" Plastic Tubing, at least 4 feet in length, and assorted ¼" quick connect fittings
- Sanitizing Cartridge
- Food Coloring

1. Check to ensure that the Red Heater and Compressor Power Switch is the *O=OFF* position.

NOTE: Switches have internal LED that illuminates when placed in *I=ON* position.



2. Turn off the water supply and unplug the unit.
3. Remove Top Cover
4. Remove Reservoir Lid
5. Remove Hot Tank Drain cap on back of unit and allow all water to drain from unit. It is not necessary to drain the Cold Tank.

- When unit has finished draining, replace Hot Tank drain cap.
- Mix descaler per instructions.

- Add descaling mixture to Reservoir Port until filled (to ensure the Reservoir Port is full, the descaling mixture starts to overflow into the Reservoir. This will ensure that the Hot Tank is full of the descaling mixture.



- Turn on water supply and plug in unit.
- Allow reservoir to fill.
- Turn on the Red Heater and Compressor Power Switch. *I=ON* position.



- Allow descaling mixture to remain in Hot Tank for 15 minutes (exposure time may be affected by local water conditions).
- Flush Cold and Hot Tanks unit until all descaler is removed.





TIP: Adding food coloring to water prior to flushing can assist determining if the descaler has been flushed from the Hot Tank. When water runs clear it is an indication that the descaling mixture has adequately flushed.



⚠ WARNING! HOT WATER HAZARD. *Unit Produces Very Hot Water and Steam. Always use insulated and chemically compatible containers and let unit cool down before draining the Hot Tank to avoid injury.*

⚠ CAUTION! MUST REPLACE HOT TANK 3-5 YEARS DEPENDING ON USAGE. *The Hot Tank and its controls must be replaced a minimum of every 3-5 years depending on usage to ensure efficient and dependable operation.*

⚠ WARNING! REINSTALL ALL PANELS AND COVERS. *Always reinstall all panels, protective covers, and fasteners after servicing equipment. Failure to do so could result in severe personal injury and will void the certifications and warranty of the equipment.*

RESETTING THE TWO HOT TANK OVERLOAD DEVICES (HIGH LIMIT SAFETY)

1.	Turn off Red Heater and Compressor Power Switch <i>O = OFF</i> on rear of unit.	
2.	Unplug the Power Cord from rear of unit.	
3.	Remove 4 Phillip Screws from the Access Panel on rear of unit and Lower Access Panel.	
4.	Locate protective metal box on rear of Hot Tank. Push down on top of metal box to access the two Overload Reset Devices.	
5.	Press the Overload Reset Devices.	
6.	Reattach the metal box by depressing the top flap of the metal box so it snaps back into its original position on the Hot Tank.	

7.	Replace the Access Panel and 4 Philips screws.	
8.	Plug in the Power Cord.	
9.	<p>Make sure the hot and cold tanks are filled with water BEFORE turning on the Red Heater and Compressor Power Switch</p> <p>⚠ CAUTION! NEVER TURN ON HEATER BEFORE FILLING HOT TANK. <i>Red Heater and Compressor Power Switch must be in the O=OFF position while the Hot Tank is empty. Damage could occur within one minute and the overload (high limit) will require manual reset if heater is turned on with an empty Hot Tank.</i></p>	
10.	Verify the cooler is fully operational before installing it at the customers' site.	

WL290 DRAWINGS AND PARTS LISTS

Yellow = Consumables

Green = Recommended
spare parts

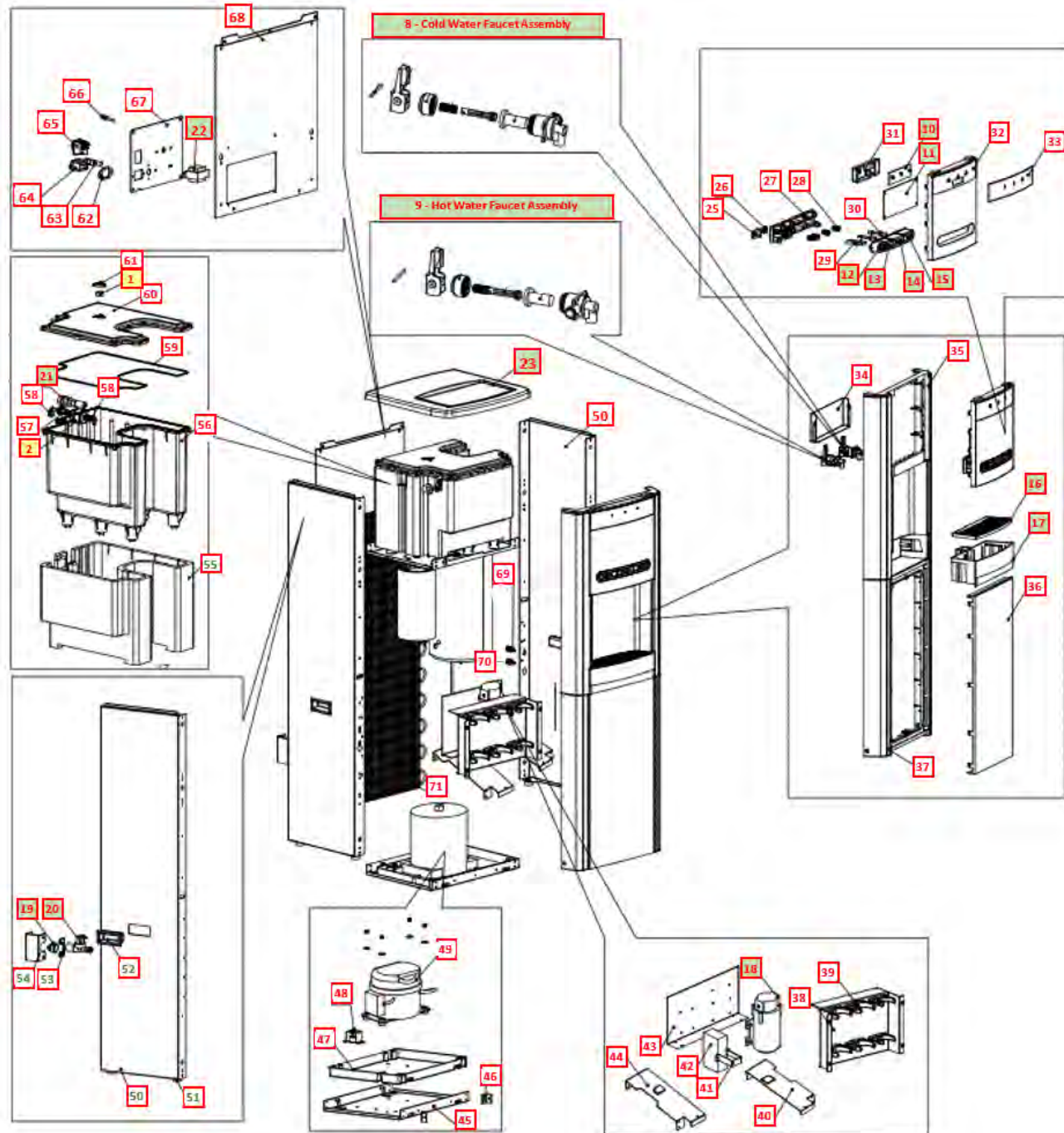

WL290 DRAWINGS AND PARTS LISTS

Wetted Drawing

Yellow = Consumables

Green = Recommended spare parts

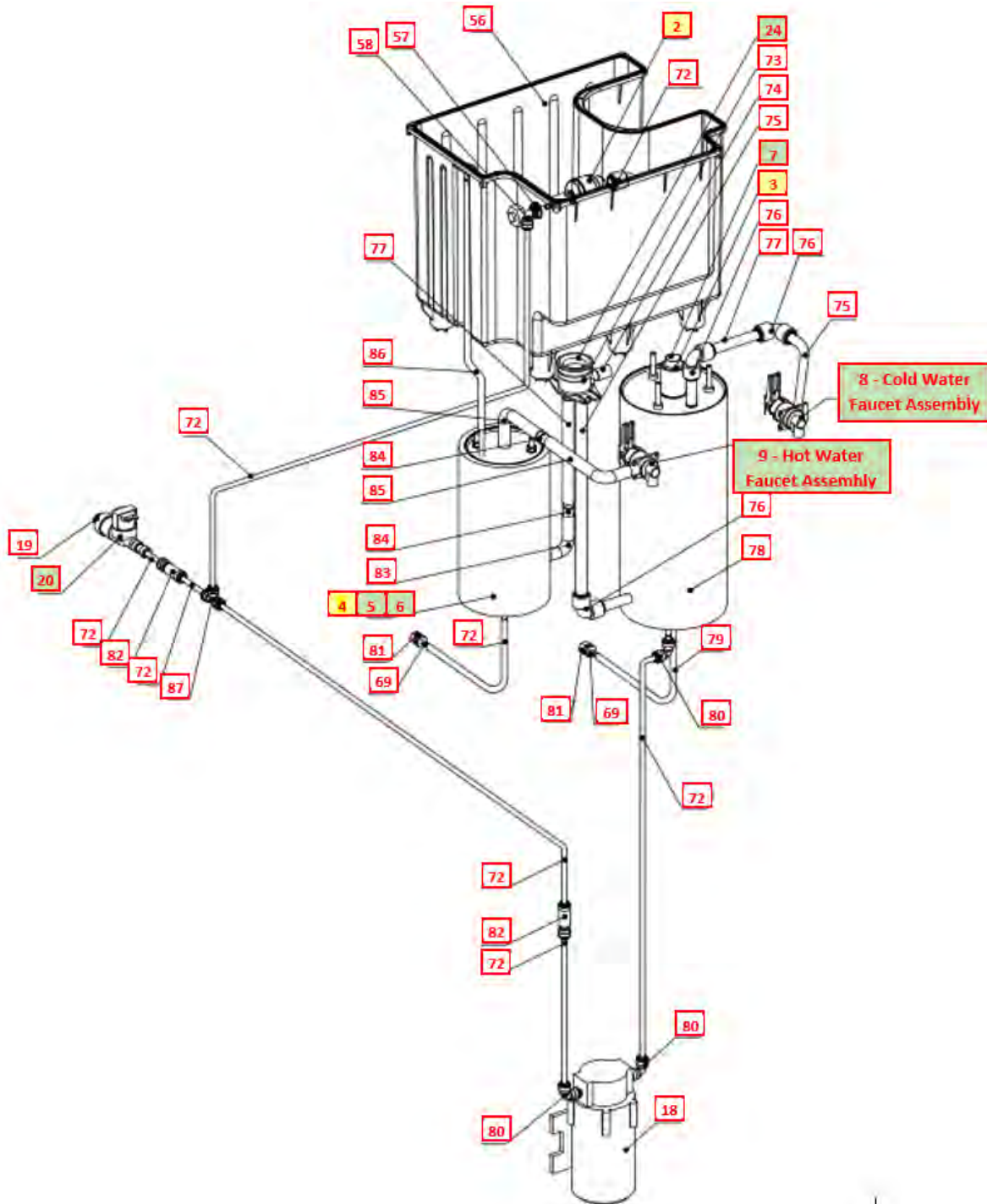

No	WLCP Part Number	Description	Factory Part Number	Stocked?	
Consumables					
1	19-1052	Carbon Air Filter	PU-4108	Yes	
2	AK-0005-L00-00	Small Inline GAC Filter	AK-0005-L00-00	Yes	
3	10-2350	8W UV Lamp Assembly with Starter	CT-2083	Yes	
4	HT-0010-I00-00	Hot Tank with Sensor <i>Replace every 3-5 years depending on usage</i>	HT-0010-I00-00	Yes	
Not Shown	FT-0035	GAC Filter - 10" Carbon Activated Inline Filter – Optional *Element is P/N FT-0038	FT-0035-IL-WLT	Yes	
Not Shown	FT-0063	Carbon Block - 10" CBC 1 Micron Lead and Cyst Reduction Inline Filter – Optional *Element is P/N FT-0064	FT-0063-IL-WLT	Yes	
Not Shown	FT-0053	Sediment Filter - 10" Sediment 20 Micron Inline Filter – Optional *Element is P/N FT-0055	FT-0053-IL-WLT	Yes	
Not Shown	01-2076	Scale Kleen	NA	Yes	
Recommended Spare Parts					
5	12-1360	Hot Tank Overload Devices (High Safety Limit). - 105°C (221°F) <i>Recommend stocking 1 each per every 10 units purchased</i>	HT-3012	Yes	
6	12-6900	Hot Tank Overload Devices (High Safety Limit). Metal Cover <i>Recommend stocking 1 each per every 10 units purchased</i>	ST-8289	Yes	

7.1	10-1400	Quartz Sleeve for 8W Lamp <i>Recommend stocking 1 each per every 10 units purchased</i>	CT-2002	Yes	
7.2	10-2500	Black O-Ring for Quartz sleeve <i>Recommend stocking 1 each per every 10 units purchased</i>	CT-2006	Yes	
8	19-1051	Cold Water Faucet Assembly <i>Recommend stocking 1 each per every 10 units purchased</i>	PL-1260-E	Yes	
9	19-1050	Hot Water Faucet Assembly <i>Recommend stocking 1 each per every 10 units purchased</i>	NA	Yes	
8.1 9.1	19-1063	Faucet Silicon Stopper <i>Recommend stocking 1 each per every 10 units purchased</i>	PU-4117	Yes	
10	EN-0046-L00-00	Display PCB <i>Recommend stocking 1 each per every 10 units purchased</i>	EN-0046-L00-00	Yes	
11	EN-0045-L00-00	Main PCB <i>Recommend stocking 1 each per every 10 units purchased</i>	EN-0045-L00-00	Yes	
12	19-1043	Hot Water Safety Push Button <i>Recommend stocking 1 each per every 10 units purchased</i>	PL-1265	Yes	
13	19-1040	Hot Water Push Button <i>Recommend stocking 1 each per every 10 units purchased</i>	PL-1262	Yes	
14	NA	Middle Button <i>Recommend stocking 1 each per every 10 units purchased</i>	PL-0169-L00-03	Yes	
15	NA	Cold Water Push Button <i>Recommend stocking 1 each per every 10 units purchased</i>	PL-0148-L00-00	Yes	
16	19-2015	Drip Tray Grill <i>Recommend stocking 2 each per every 10 units purchased</i>	PL-1270-C	Yes	

17	19-2020	Drip Tray Body <i>Recommend stocking 2 each per every 10 units purchased</i>	PL-1289-B	Yes	
18	CT-0021-L00-00	Self-Suction Pump <i>Recommend stocking 1 each per every 10 units purchased</i>	CT-0021-L00-00	Yes	
19	Purchase from John Guest	Inlet Solenoid Valve JG Adaptor 1/4 (CI320816S) <i>Recommend stocking 1 each per every 10 units purchased</i>	PU-4104-DP	Purchase from John Guest	
20	19-1001	Inlet Solenoid Valve 120V <i>Recommend stocking 1 each per every 10 units purchased</i>	PU-4096	Yes	
21	19-1004	Water Level Controller with Wire <i>Recommend stocking 1 each per every 10 units purchased</i>	PU-4100	Yes	
22	EL-5006-A CN	UV Lamp Ballast 110V/60Hz <i>Recommend stocking 1 each per every 10 units purchased</i>	10-3010	Yes	
23	19-5005	Black Top Cover <i>Recommend stocking 1 each per every 10 units purchased</i>	PL-1254	Yes	
24	19-1057	Silicon Seal for Inlet Port to Tanks <i>Recommend stocking 1 each per every 10 units purchased</i>	PU-4109	Yes	
Remainder of parts					
25	19-1045	Hot Safety Push Button Safety Lock	PL-1267	Yes	
26	NA	Hot Water Safety Lock Spring	CST-8327	No	
27	19-1047	Faucet Bracket	PL-1269	Yes	





28	NA	Faucet Push Pin Spring	CST-8326	No	
29	19-1044	Hot Water Safety Button Pin	PL-1266	Yes	
30	19-1046	Faucet Push Pin	PL-1268	Yes	
31	NA	Display PCB Cover	PL-1347	No	
32	NA	Front Hatch Panel	PL-0147-L00-00	No	
33	NA	LED Label	LP-0335-L00-00	No	
34	NA	Main Printed Circuit Board (PCB) Cover	ST-0143-L00-00	No	
35	19-1034	Top Front Panel for Drip Tray <i>*Request to be shipped with Hot Water Safety Sticker P/JN LP-7169 WLCP PN 12-1001.</i>	PL-1255	Yes	
35.1	12-0001	Hot Water Safety Sticker	LP-7169	Yes	
36	19-5015	Lower Front Insert Panel	PL-1149-A	Yes	
37	19-1035	Bottom Panel	PL-1256	Yes	

38	NA	Filter Bracket	ST-0145-L00-00	No	
39.1	10-3099	2 ½" Filter Clip	PU-4024	Yes	
39.2	10-3098	2" Filter Clip	PU-4025	Yes	
40	NA	Rail Bracket – Right	ST-0172-L00-00	No	
41	NA	Adaptor Bracket	ST-8315	No	
42	NA	Power Adaptor	EL-0126-L00-00	No	
43	NA	Pump Bracket	ST-0173-L00-00	No	
44	NA	Rail Bracket – Left	ST-0171-L00-00	No	
45	NA	Bottom Base	ST-0174-L00-00	No	
46	19-1021	Side Panel Bracket	ST-8229	Yes	
47	NA	Leak Tray	PL-0149-L00-00	No	

48	19-1025	Level Sensor Bracket	ST-8232	Yes	
49	NA	Compressor 120V	CO-0011-L00-00	No	
50	19-1019	Side Panel	ST-8212	Yes	
51	10-3083	Rubber Feet	ST-8016	Yes	
52	12-8058	Side Panel Plastic Handle	PL-1123	Yes	
53	19-1020	Inlet Solenoid Valve Bracket	ST-8214	Yes	
54	19-1026	Inlet Solenoid Valve Cover	ST-8233	Yes	
55	NA	Reservoir Thermal Insulation	PL-0090-L00-BL	No	
56	19-1037	3 Gallon Plastic Reservoir	PL-1258	Yes	
57	10-3067	Bulkhead Union 1/4" x 1/4" John Guest P/N PI1208S	PU-4028-A	Yes	
58	Purchase from John Guest	JG Stem Elbow Connector 1/4" * 1/4" - Acetal PI220808S)	PU-4066-A	No	
59	19-1056	Reservoir Cover Silicon Seal	PU-4099	Yes	

60	19-1038	Reservoir Cover	PL-1259	Yes	
61	19-1076	Air Filter Silicon Cap	PL-1290	Yes	
62	19-1015	Gasket for Power Socket	ST-8052	Yes	
63	10-3014	Fuse Holder and Fuse 120V / 15A with One Wire	EL-5053	Yes	
64	19-1090	Power Line Noise Filter, ElectroMagnetic Interference filter (EMI)	EL-5029	Yes	
65	10-3008	Red Compressor and Heater Switch	EL-5004	Yes	
66	NA	Switch and Wire to Filter Reset Timer	EL-0131-L00-00	No	
67	NA	Access Metal Cover	ST-0181-L00-00	No	
68	19-1017	Back Panel	ST-8210	Yes	
69	14-5011	Drain Valve Body for 5/16" *14-5011 includes Drain Valve Body and Cap *See #81	CT-2031-A	Yes	
70	NA	Drain Valve Nut for 1/4" and 5/16"	CT-2082	No	
71	NA	Wire Condenser	CO-0009-L00-00	No	
71.1	12-1001	Filter Dryer	CO-9008	Yes	
72	Purchase from John Guest	JG LLD PE Tube - Blue O.D.1/4"John Guest P/N PE-08-BI-1000F-B	PU-4031-A	No	

73	19-1039	Water Inlet to Port to Tanks	PL-1261	Yes	
74	NA	Silicon Stopper Cap Blocks Ambient Port	PU-4117	No	
75	19-1099	1/2" Pipe White Tubing - John Guest PN PE-16-GI-0250F-W	PU-4126-KR	Yes	
76	Purchase from John Guest	JG 1/2" Elbow fitting (PP0316W)	Purchase from John Guest	No	
77	NA	HK silicone 1/2" pipe (natural)	PU-4126-B	No	
78	NA	Cold Tank with Thermistor	CT-0013-L00- 00	No	
78.1	CT-2081	Thermistor	CT-2081	Yes	
79	10-3062	JG LLDPE Tube - Blue 8mm John Guest P/N PE-0806-100M-B	PU-4014-A	Yes	
80	Purchase from John Guest	JG Equal Elbow Connector 1/4" (PI0308S)	Purchase from John Guest	No	
81	14-5011	Drain Valve Cap for 5/16" – 3/4" *14-5011 includes Drain Valve Body and Cap - See #69	CT-202814	Yes	
82	12-5690	JG Non-Return Valve 1/4"(1/4SCV)	PU-4057	Yes	
83	19-1058	Silicon Elbow Tube Pipe 25*40	PU-4110	Yes	
84	NA	Silicon Pipe Straight Connector	PU-4101	Yes	

85	19-1060	Silicon Pipe 48.5*155 Elbow	PU-4112	Yes	
86	NA	Silicon Pipe 5/16"	PU-4064-L00-00	No	
87	Purchase from John Guest	JG Equal Tee Connector 1/4" (PI0208S)	PU-4011-A	No	
Not Shown	10-3007	Power Cord 120V – 1840 mm	EL-5001-B	Yes	

WL290 WATER FLOW DIAGRAM

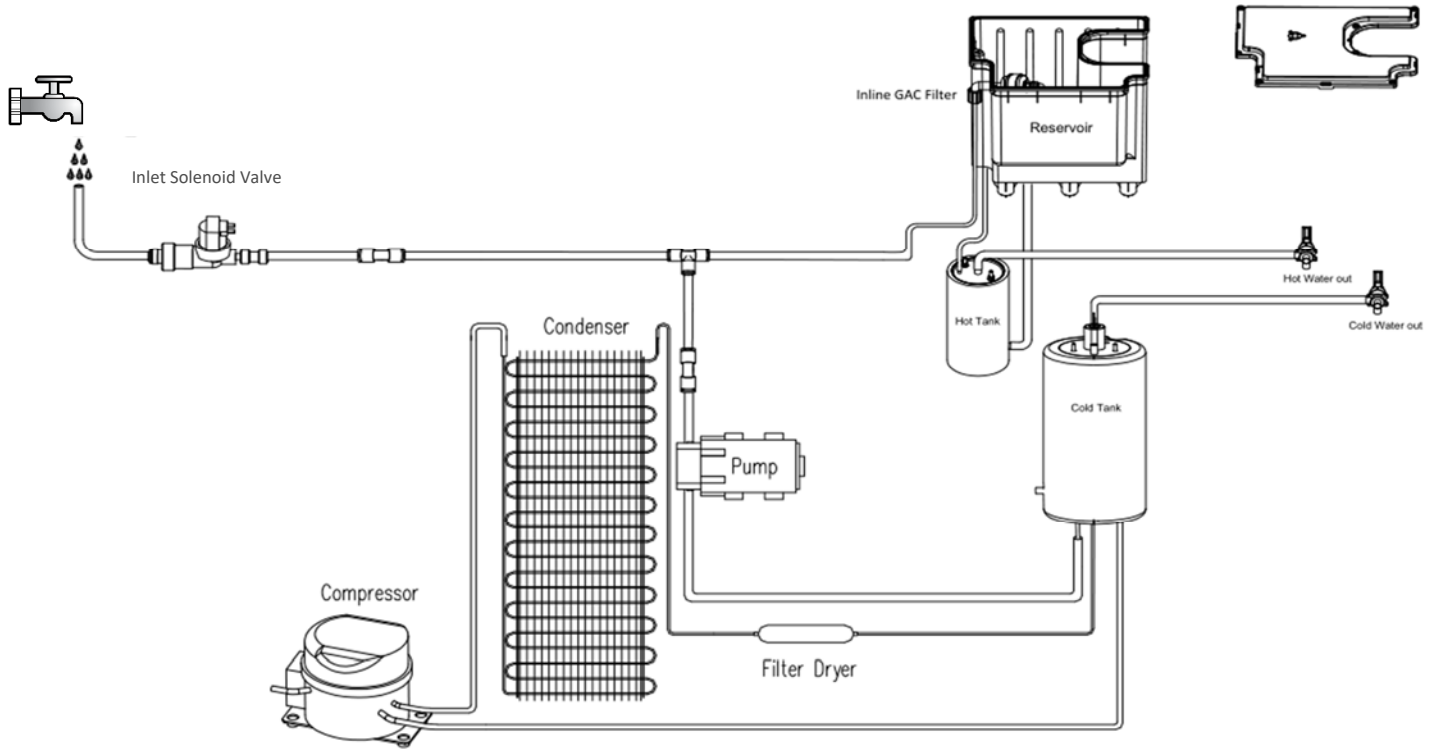

WL290 ELECTRICAL DIAGRAM

⚠ DANGER! HIGH VOLTAGE ELECTRICAL HAZARD. PCB (Printed Circuit Board) contains High Voltage. Only trained and qualified technicians should attempt live testing.

