

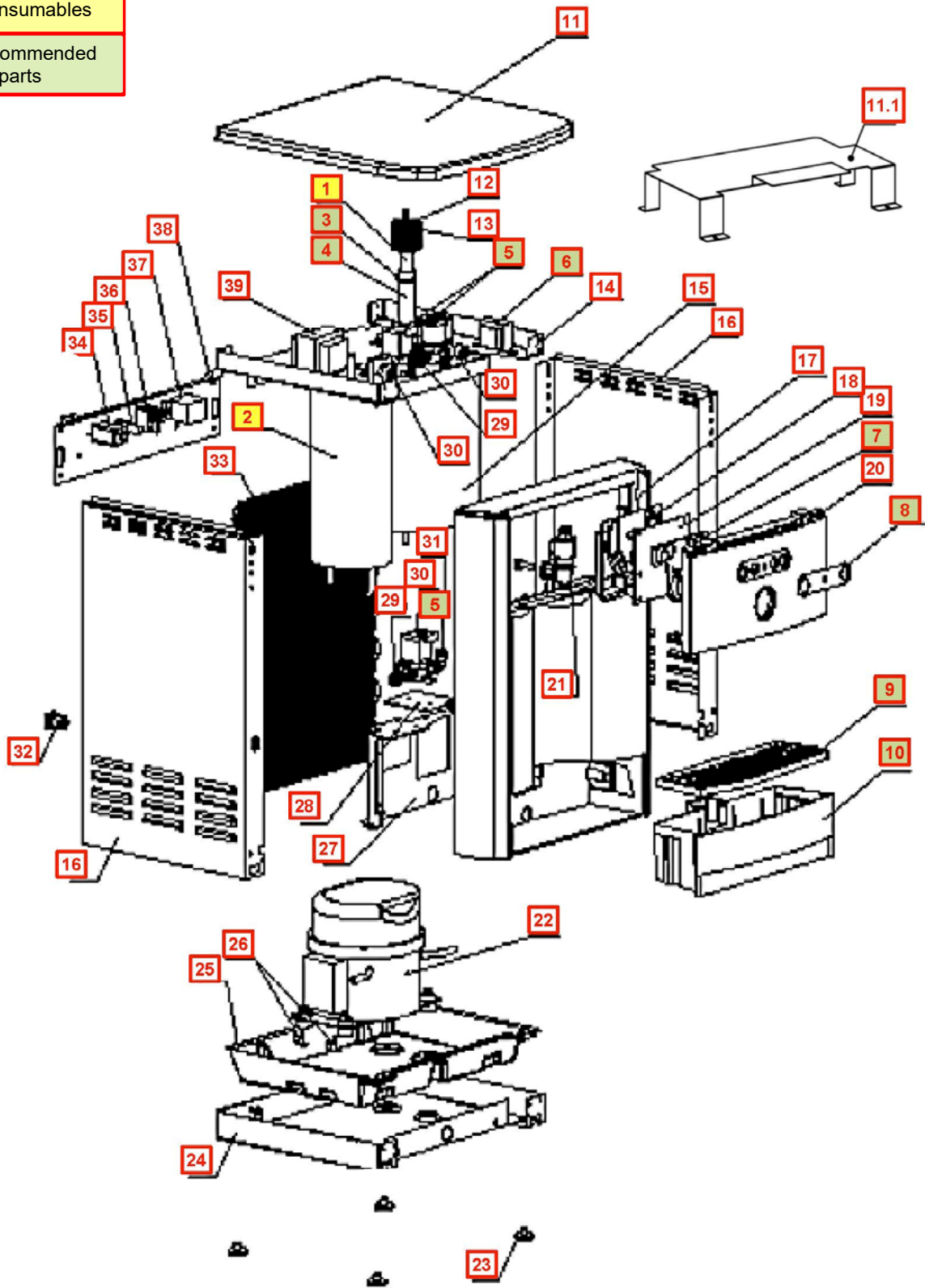











WL250 COUNTER TOP DRAWING AND PARTS LIST

Yellow = Consumables
 Green = Recommended spare parts



No	WLCP Part No.	Description	Part No	Stocked?	
Consumables					
1	12-2350	4W Lamp Assembly	CT-2084	Yes	
2	12-1406	Hot Tank 1.6 Liter (.42 Gallons) 87°C (189°F) – Counter Top <i>Recommend stocking 2 each per every 10 units purchased</i>	HT-3018-A	Yes	
Not Shown	FT-0035	GAC Filter - 10" Carbon Activated Inline Filter – Optional	FT-0035-IL-WLT	Yes	
Not Shown	FT-0063	Carbon Block - 10" CBC 1 Micron Lead and Cyst Reduction Inline Filter – Optional	FT-0063-IL-WLT	Yes	
Not Shown	FT-0053	Sediment Filter - 10" Sediment 20 Micron Inline Filter – Optional	FT-0053-IL-WLT	Yes	
Recommended Spare Parts					
2.1	12-1360	Overload with Manual Reset - 97°C (206°F) <i>Recommend stocking 2 each per every 10 units purchased</i>	HT-3012	Yes	
2.2	12-1303	Hot Tank Thermostat - 87°C (189°F) <i>Recommend stocking 2 each per every 10 units purchased</i>	HT-3013A	Yes	
2.3	12-6900	Thermostat and Overload Metal Cover <i>Recommend stocking 2 each per every 10 units purchased</i>	ST-8290	Yes	
3	10-2500	Black O-Ring for Quartz Sleeve <i>Recommend stocking 1 each per every 10 units purchased</i>	CT-2006	Yes	
4	14-1051	Quartz Sleeve for 4W Lamp <i>Recommend stocking 1 each per every 10 units purchased</i>	CT-2026	Yes	
5	12-1500	Solenoid Valve 1000 mm <i>Recommend stocking 2 each per every 10 units purchased</i>	PU-4016	Yes	





5.1	CU-0001	Solenoid Cushion <i>Recommend stocking 2 each per every 10 units purchased</i>	CU-0001	Yes	
6	10-3010	UV Lamp Ballast 110V/60Hz <i>Recommend stocking 2 each per every 10 units purchased</i>	EL-5006-A CN	Yes	
7	12-8056	Silicon Button Key Mat <i>Recommend stocking 5 each per every 10 units purchased</i>	PL-1153	Yes	
8	12-8057	Button Label <i>Recommend stocking 2 each per every 10 units purchased</i>	LP-7084	Yes	
9	12-8150	Drip Tray Grill – Charcoal <i>Recommend stocking 4 each per every 10 units purchased</i>	PL-1152	Yes	
10	12-8055	Drip Tray - Charcoal with Waterlogic Logo <i>Recommend stocking 4 each per every 10 units purchased</i>	PL-1156	Yes	
Not Shown	10-3048	Faucet Nipple – Blue with Screen <i>Recommend stocking 2 each per every 10 units purchased</i>	PL-1013	Yes	
Not Shown	10-2600	Natural Faucet O-Ring – Silicon White <i>Recommend stocking 2 each per every 10 units purchased</i>	CT-2007	Yes	
Not Shown	01-2076	ScaleKleen <i>Recommend stocking 2 each per every 10 units purchased</i>	NA	Yes	
Remaining Parts					
11	12-8060	Flat Top Cover - Charcoal with Texture	PL-1249-CN	Yes	
11.1	NA	Metal Cover (Under Top Cover)	ST-0049-L00-00	No	

12	10-8085	UV Lamp Fixing Rubber	CT-2001-B	Yes	
13	12-1210	UV Lamp Retaining Threaded Nut	PL-1128	Yes	
14	12-3165	Upper Shelf	ST-8150	Yes	
Not Shown - on Top Shelf	12-8510	UV 3minutes Timer PCB - Hot and Cold	AK-0008-A	Yes	
Not Shown - on Top Shelf	NA	3minutes UV Timer PCB Fixing Bracket	ST-8287	No	
15	12-3110	2L UV Cold Tank Assembly	CT-2060	Yes	
16	12-8062	Side Panel	ST-8245	Yes	
17	12-8050	Front Upper Drip Tray Insert Panel – <i>when purchasing, also request Hot Water Caution Label LP-7169 / 12-0001 to adhere to front of this panel.</i>	PL-1146	Yes	
17.1	12-0001	Hot Water Caution Label – <i>adhere to Front Upper Drip Tray Insert Panel.</i>	LP-7169	Yes	
18	12-3160	PCB Cover	PL-1298	Yes	

19	12-3115	PCB for Hot and Cold for Leak Detection System	EN-6085-A	Yes	
19.1	10-3017	PCB Stand-off Pin	EN-6059	Yes	
20	12-8051	Front Hatch Panel Charcoal with UV logo <i>Sold Separately: Button Label (P/N 12-8057) & Silicon Button Key Mat (P/N 12-8056)</i>	PL-1147-B	Yes	
21	10-2700	Faucet Assembly	PL-1011	Yes	
<p>Verify compressor in machine before ordering parts as the Compressor P/N CO-0020-L00-00 and 10-2200 (CO-0001A) and related parts are not interchangeable.</p>					
22A.1	CO-0020-L00-00	LG Compressor 120V R134A CSB035LJCM	CO-0020-L00-00	Yes	
22A.2	CO-0019-L00-00	Compressor Capacitor	CO-0019-L00-00	Yes	
22A.3	ST-0216-L00-00	Capacitor Bracket	ST-0216-L00-00	Yes	
22A.4	CO-0017-L00-00	PTC Relay	CO-0017-L00-00	Yes	
22A.5	CO-0018-L00-00	Overload Protector	CO-0018-L00-00	Yes	
22B.1	10-2200	Compressor (R134a 1/8HP) 120V/60Hz	CO-9001-A	Yes	
22B.2	10-3003	Compressor Starter Relay	CO-9016	Yes	

22B.3	10-5018	Compressor Overload	CO-9015	Yes	
22B.4	12-1001	Filter Dryer	CO-9008	Yes	
23	12-3150	Unit Rubber Feet	PL-1251-CN	Yes	
24	12-3170	Bottom Tray	ST-8151	Yes	
25	12-3155	Leak Tray	PL-1294	Yes	
26	12-3180	Leak Containment Tray Clip (sensor 0.5mm)	ST-8207-CN	Yes	
26.1	NA	Leak Sensor Wire	EL-5076-KR	No	
27	12-3175	Filter Bracket	ST-8152	Yes	
27.1	10-3099	3" Filter Clip	PU-4024	Yes	
27.2	10-3098	2" Filter Clip for In-Line Filter	PU-4025	Yes	
28	12-3195	Leak System Inlet Solenoid Bracket	ST-8244	Yes	
29	Purchase from John Guest	JG Equal Tee Connector 1/4" (P10208S)	PU-4011	No	

30	Purchase from John Guest	JG Reducing Elbow Connector 5/16" * 1/4" (PI211008S)	PU-4007	No	
31	Purchase from John Guest	JG Equal Elbow Connector 1/4" (PI0308S)	PU-4008	No	
32	10-3067	Bulkhead Union 1/4" x 1/4" John Guest P/N PI1208S	PU-4028-A	Yes	
32.1	Purchase from John Guest	JG 1/4" Stopper PI0808S (used with Bulkhead Union 1/4" x 1/4" John Guest P/N PI1208S)	PU-4086	Yes	
33	12-3100	Wire Condenser	CO-9031	Special Order	
34	10-4013	Power Line Noise Filter, ElectroMagnetic Interference filter (EMI)	EL-5016	Yes	
35	10-3014	Fuse Holder and Fuse 120V / 15A with One Wire	EL-5053	Yes	
35.1	10-3013	Fuse 120V / 15A	EL-5010	Yes	
36	10-3008	Red Compressor and Heater Switch	EL-5004	Yes	
37	12-1101	Cold Tank Thermostat	CT-2016	Yes	
37.1	PL-0326	Cold Thermostat Cover Label	PL-0326-L00-00	Yes	
38	12-8061	Silver Back Panel	ST-8216	Yes	

39	12-3117	Power Transformer 120V	EL-5003-A	Yes	
Not Shown	12-8210	UV Wire Harness Set for Hot and Cold	EL-5048	Yes	
Not Shown	Purchase from John Guest	JG LLD PE Tube - Blue O.D.1/4" John Guest P/N PE-08-BI-1000F-B	PU-4031-A	No	
Not Shown	10-3062	JG LLDPE Tube - Blue 8mm John Guest P/N PE-0806-100M-B	PU-4014-A	No	
Not Shown	10-7040	Silicon Tube 5/16" for Hot Water	PU-4064	Yes	
Not Shown	10-3007	Power Cord 120V – 1840 mm	EL-5001-B	Yes	