

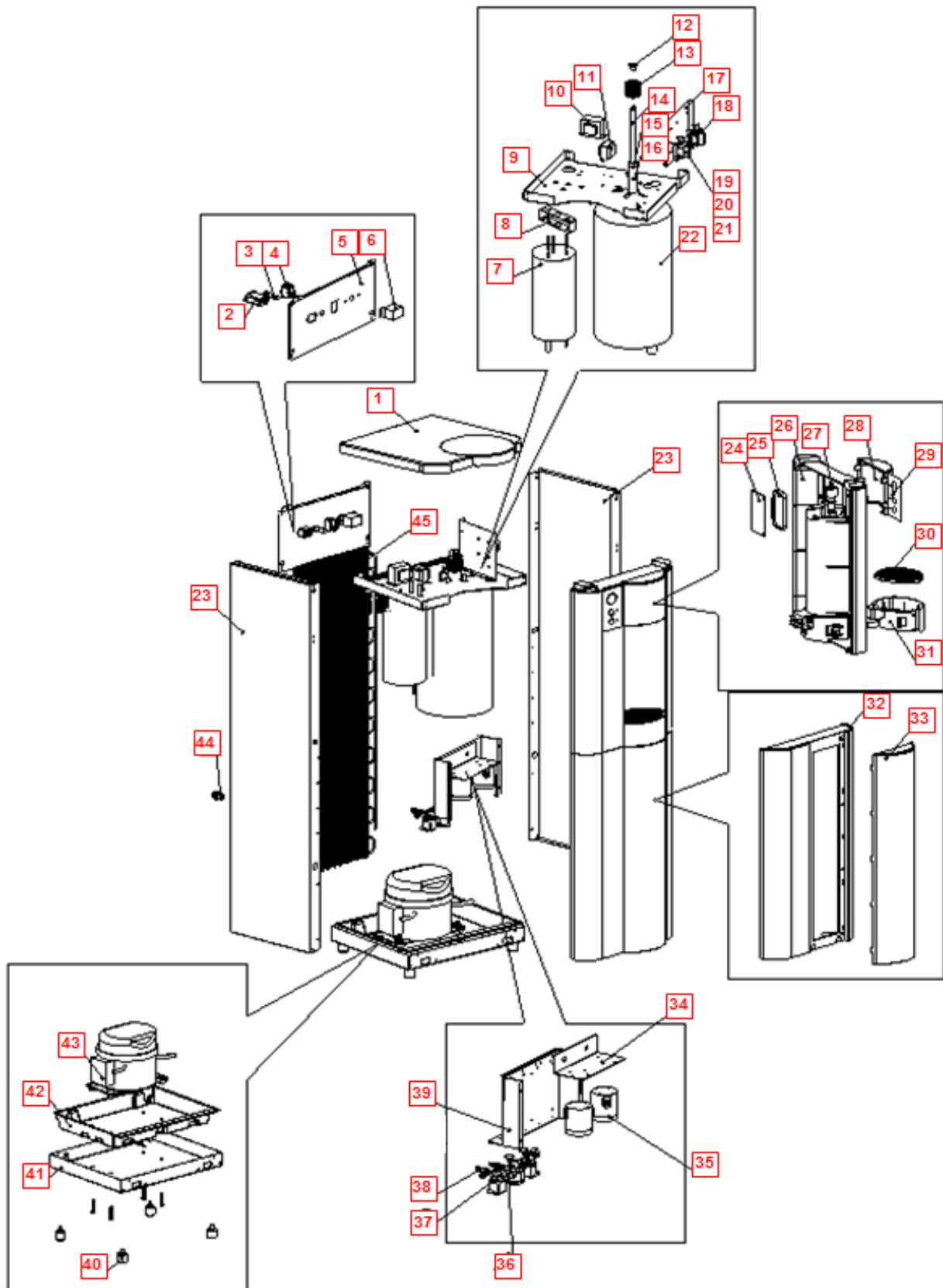

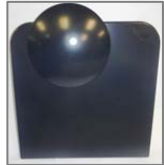

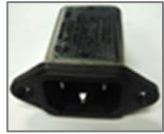





Waterlogic infiniti UV TOWER PARTS DRAWING AND PARTS LIST



No	Part No	Description	WLCP PN	
1	NA	Top Cover - Charcoal	PL-0107-L00-CS	
2	10-4013	Socket with ElectroMagnetic Interference Filter (EMI)	EL-5016	
3	10-3014	Fuse Holder and Fuse 120V / 15A with One Wire	EL-5053	
3.1	10-3013	Fuse 120V / 15A	EL-5010	
4	10-3008	Red Compressor and Heater Switch	EL-5004	
5	NA	Back Panel - Charcoal	ST-8154	
6	12-1101	Cold Tank Thermostat	CT-2016	
6.1	LP-0326	Cold Thermostat Cover Label	LP-0326-L00-00	
7	10-4029	Hot Tank 1.6L 120V/500W with Thermistor	HT-3024	
7.1	12-1360	Overload with Manual reset - 105°C / 221°F	HT-3012	
8	12-8006	Hot Tank Fixing Bracket 400mm Tower Only	ST-8120	
9	12-8003	Upper Shelf Tower Only	ST-8136-R2	

10	12-3117	Power Transformer 120V	EL-5003-A	
11	10-3010	UV Lamp Ballast 110V/60Hz	EL-5006-A CN	
12	10-8085	UV Lamp Fixing Rubber (Silicon)	CT-2001-B	
13	12-1210	UV Lamp Retaining Threaded Nut	PL-1128	
14	10-2350	UV Lamp 8W Assembly Tower Only	CT-2083	
14.1	NA	UV Lamp Lead Wire & Starter Tower Only	CT-2019	
15	10-2500	Black O-Ring for Quartz Sleeve	CT-2006	
16	10-1400	Quartz Sleeve for 8W Lamp Tower Only	CT-2002	
17	NA	Relay PCB	EN-0010-L00-00	
18	12-5245	Main PCB Fixing Bracket Tower Only	ST-8165-CN	
19	12-8510	3 Minutes Timer PCB.	AK-0008-A	
20	NA	Plastic PCB Supports (One side)	EN-6059-A	

21	10-3017	Plastic PCB Support	EN-6059	
22	NA	4L Cold Tank Tower Only	CT-2050	
23	11-2020	Side Panel – Charcoal Tower Only	ST-8153	
24	NA	Display PCB	EN-0033-L00-00	
24.1	20-1005	Jumper Pin	EN-6082	
25	NA	Dispensing Silicon Buttons	PL-0109-L00-00	
26	11-2085	Drip Tray Insert Panel Charcoal	PL-1157	
27	10-2700	Faucet Assembly	PL-1011	
27.1	10-2600	Natural Faucet O-Ring – Silicon White	CT-2007	
27.2	10-3048	Faucet Nipple – Blue with Screen	PL-1013	
28	NA	Top Insert Hatch Panel - Silver	PL-0127-L00-00- INF	

29	NA	Display Button Label	LP-7087	
30	NA	Drip Tray Grill - Silver	PL-1163-L00-SI	
31	NA	Drip Tray - Silver - No Logo	PL-1162-L00-SI	
32	11-2015	Bottom Front Panel Tower Only	PL-1159	
33	11-2030	Front Bottom Insert Panel Silver	PL-1160	
34	NA	Filter Mounting Bracket Tower Only	ST-8248	
35	NA	Omnipure Non-Valved Head (Q NON VALVED HEAD JJ)	PU-4075	
36	Purchase from John Guest	JG Equal Elbow Connector 1/4" (PI0308S)	PU-4008-A	
37	12-1500	Solenoid Valve DC24V 1000mm	PU-4016	
37.1	CU-0001	Solenoid Cushion	CU-0001	
38	Purchase from John Guest	JG Equal Tee Connector 1/4" (PI0208S)	PU-4011-A	

39	12-8005	Filter Bracket Tower Only	ST-8138	
39.1	NA	Rubber O-Ring for Filter Bracket	PL-1208CN	
40	10-3083	Unit Rubber Feet Tower Only	ST-8167-CN	
41	12-8004	Bottom Tray Tower Only	ST-8137	
42	NA	Freestanding Leak Tray Tower Only	PL-1294-A	
42.1	NA	Leak Detector Sensor Wire	EL-5074-A	
42.2	12-3180	Leak Containment Tray Clip (sensor 0.5mm)	ST-8207-CN	
43	10-2200	Compressor (R134a 1/8HP) 110V/60Hz	CO-9001-A	
44	10-3067	Bulkhead Union 1/4" x 1/4" John Guest P/N P11208S	PU-4028-A	
45	12-8102	Wire Condenser Tower Only	CO-9027	
Not Shown	11-2005	Power Cord 120V – 1825 mm	EL-5001-A	
Not Shown	Purchase from John Guest	JG Reducing Elbow Connector 5/16" * 1/4" (P1211008S)	PU-4007-A	
Not Shown	10-3062	JG LLDPE Tube - Blue 8mm John Guest P/N PE-0806-100M-B	PU-4014-A	

Not Shown	Purchase from John Guest	JG LLD PE Tube - Blue O.D.1/4"John Guest P/N PE-08-BI-1000F-B	PU-4031-A	
Not Shown	10-7040	Silicon Tube 5/16" for Hot Water	PU-4064	